

EDDYSTONE

AMATEUR BAND COMMUNICATIONS RECEIVER

Model "888A"

Instruction Manual

The Eddystone "888A" receiver has been designed essentially for use in the amateur bands and has six ranges, each covering a major amateur band.

The expanded scales, each practically twelve inches long, gives that large degree of band spread so much sought after, and another advantage is that the tuned circuits have constants which lead to optimum performance on each individual range. All but two of the twelve valves are of the miniature type.

The receiver is of the double superheterodyne type, with a high first intermediate frequency, for good image protection, and a low second intermediate frequency, for high gain and selectivity. The latter is continuously variable, and this feature, in conjunction with the separate RF, IF and AF gain controls, enables maximum intelligibility to be obtained from both telegraphy and telephony signals, under the varying conditions of operation met within the amateur bands.

The six switched ranges are based on international agreements and are as follows :—

| | |
|------------------------------|----------------------------|
| 28,000 kc/s. to 30,000 kc/s. | 7,000 kc/s. to 7,300 kc/s. |
| 21,000 kc/s. to 21,500 kc/s. | 3,500 kc/s. to 4,000 kc/s. |
| 14,000 kc/s. to 14,350 kc/s. | 1,800 kc/s. to 2,000 kc/s. |

RECOMMENDED ACCESSORIES



DIECAST LOUDSPEAKER

Cat. No. 688

This robust and handsome speaker is a correct electrical match into the "888A" receiver. A 5" diameter permanent magnet unit of high efficiency is mounted in a diecast housing 7" in diameter. Impedance is 2.5 to 3 ohms and finish ripple black, with chromium plated feet. Complete with lead.

SIGNAL STRENGTH METER

The moving-coil movement and the necessary resistors, including the zero adjuster potentiometer, are fitted inside a neat diecast housing, finished a fine ripple black. The movement has a 200 microampere full scale deflection and the scale is clearly calibrated in "S" units and decibels above S9, on the basis of a 4db increase in carrier level for each "S" point. The leads terminate in an octal plug, which fits directly into the socket marked "A" at the rear of the receiver.



Cat. No. 669



VIBRATOR POWER UNIT

Cat. No. 687/1

This unit permits direct operation of the "888A" receiver from a six-volt accumulator. It consists of a transformer, non-synchronous vibrator, rectifier valve (6X5G), on/off switch, and filter components, totally enclosed in a metal cabinet finished ripple black. The filtering and screening are very effective and RF interference is eliminated. Smoothing components are not included, since these already exist in the receiver. The leads connecting the Unit to the receiver are terminated with octal plugs and a heavy cable is provided for connection to the battery.

RECEIVER MOUNTING BLOCKS

Cat. No. 774

These useful blocks raise the front of the receiver. The latter takes up an inclined position which is more convenient for operation.

The blocks can be bolted quickly and easily to the underside of the receiver cabinet (tapped holes already exist) or they can simply be held in place by the weight of the receiver. Material is diecast aluminium, finished ripple black. Dimensions $6\frac{1}{4}$ " long and $2\frac{1}{2}$ " deep at the front.



STRATTON & Co. Ltd., West Heath, Birmingham 31

Cables : "STRATNOID" Birmingham

Telephone : PR1ory 2231-2-3-4

EDDYSTONE "888 A" RECEIVER

GENERAL SERVICING

The "888 A" receiver operates from A.C. mains supplies of 40/60 cycles, the consumption being approximately 75 watts. The fuse is in series with the H.T. secondary centre tap to earth and it is preferable to use a delayed "Magnickel" type, rated at 250 mA.

The holders for the lamps which illuminate the dial are sprung into place. To change a lamp, it is only necessary to press the side of the holder and pull out. The lamp is rated at 6.5 volts 0.3 amperes (M.B.C. round radio panel type).

Should the performance fall off or perhaps fail completely it will be well in the first place to inspect the valves for the normal heater glow. Where a metal screening can is fitted to a valve, it is easily removable with a twist and a pull. The VR150/30 stabiliser valve normally exhibits a violet glow.

If it becomes necessary to obtain access to the interior, the cabinet can be completely removed after withdrawal of the four large screws at the rear. A check should be made against the normal operating voltages given in the table and any serious discrepancy will indicate at which stage in the circuit a fault has developed.

VALVES TYPES AND FUNCTIONS.

| Position | Type | Function |
|----------|----------------|---|
| V1 | 6BA6 | R.F. Amplifier. |
| V2 | ECH81/6AJ8 | Mixer (Signal frequency to 1620 kc/s.) |
| V3 | 6C4/L77 | Oscillator. |
| V4 | ECH81/6AJ8 | Frequency Changer (1,620 kc/s. to 85 kc/s.) |
| V5 | 6BA6 | I.F. Amplifier (85 kc/s.) |
| V6 | 6AT6/DH77 | Demodulator, AGC and first stage audio. |
| V7 | 6AL5/D77 | N.L. and "S" Meter diodes. |
| V8 | 6AQ5 | Output stage |
| V9 | 6BE6 | CW/SSB converter |
| V10 | 5Z4G | Rectifier. |
| V11 | VR150/30 (OD3) | Stabiliser. |
| V12 | 6AU6 | Crystal Calibrator Oscillator. |

All the valves, with the exception of the rectifier and stabiliser are of the miniature type.

ALIGNMENT INSTRUCTIONS.

It is assumed that test instruments are available — in particular a Signal Generator covering 85 kc/s. to 30 Mc/s., provided with internal modulation (30%) and a calibrated attenuator and an audio output meter, calibrated in milliwatts and decibels and adjustable to match an impedance of 2.5 ohms. Trimming should be carried out with a non-metallic tool such as the Eddystone Cat. No. 122T. A Philips Trimming Tool for adjusting the concentric trimmers in the RF stages will also be required.

I.F. STAGES.

The controls should be set as follows :

| | | | |
|--------------|--------------|----------------|--------------|
| R.F. Gain | Minimum | Band Selector | Range 1 |
| I.F. Gain | Maximum | Mode Switch | A.M. |
| A.F. Gain | Maximum | Noise Limiter | Off |
| Selectivity | Maximum | A.F. Filter | Off |
| Osc. Vernier | Mid position | Aerial Trimmer | Mid position |

A 30% modulated input at 85 kc/s. is applied between chassis and the grid of V4 (accessible under chassis as shown in Fig. 4). The four cores in the I.F. transformers marked "2nd" and "3rd" in Fig. 3 and 4 are adjusted to give maximum output, as indicated on the output meter. The attenuator of the S.G. should be adjusted as necessary to prevent the needle of the output meter going off the scale. An input of about 280 microvolts will normally be required to give 50 milliwatts at the speaker terminals.

Leaving the controls and connections undisturbed, the input frequency should be changed to 1,620 kc/s. and the second oscillator adjusted by moving the core in the F.C. Unit (T4 in Fig. 3) until output is maximum. Because of the slight loss in conversion, a greater input (some 2 or 3 db) will be required to give 50 milliwatts output. The change to 85 kc/s. can be obtained with the oscillator on either the high or low side of 1,620 kc/s. and two positions of the oscillator core

will give output — the lower frequency position, i.e. with the core furthest in, is the correct one.

The band selector switch should now be moved to position "6" and the 1,620 kc/s. input applied between chassis and the stator of the centre section of the gang condenser. The oscillator section of the gang condenser should be short circuited during this operation. The primary and secondary cores in the first IF transformer (see Fig. 3) are then adjusted to give maximum output and a further very slight and careful adjustment of the V4 oscillator core may give an improvement. The final IF. sensitivity should be such that 50 milliwatts output is produced for an input (at 1,620 kc/s.) of approximately 15 microvolts.

SSB/CW CONVERTER ADJUSTMENT.

The core in the oscillator unit (T7) will not normally require any adjustment, but should the B.F.O. be found to be off tune, the following procedure applies.

With the switch in the "A.M." position, a modulated signal should be applied and accurately tuned in on the receiver. The modulation is switched off, the switch pressed to SSB/CW, and with the pitch control at half mesh (white spot at top) the core in T7 (see Fig. 4) is set to give zero beat.

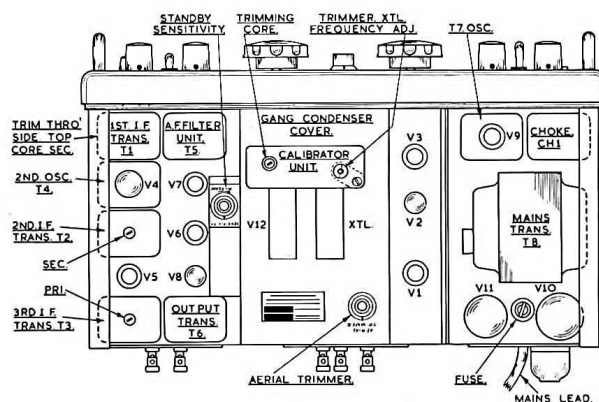

Fig. 3. Plan view of "888 A" Receiver in outline.

R.F. ALIGNMENT.

The controls remain as before except that the R.F. gain is turned to maximum. Should it be found necessary to correct discrepancies in the scale calibration, the Crystal Calibrator is switched on, the mode switch placed to SSB/CW, the white spot on the pitch control knob being in the centre position. Adjustment is then made to the cores and trimmers appropriate to each range, in the oscillator section of the coil box (see Fig. 4).

Checks and adjustments should be made at the frequencies given below, using the TRIMMER CONDENSER at the higher frequency end of the scale and the CORE at the low frequency end.

| | |
|----------|-------------------------|
| Range 1. | 28 Mc/s. and 30 Mc/s. |
| Range 2. | 21 Mc/s. and 21.5 Mc/s. |
| Range 3. | 14 Mc/s. and 14.3 Mc/s. |
| Range 4. | 7 Mc/s. and 7.3 Mc/s. |
| Range 5. | 3.5 Mc/s. and 4.0 Mc/s. |
| Range 6. | 1.8 Mc/s. and 2.0 Mc/s. |

It will be found essential when making all adjustments within the coil box, both with cores and trimmers, to use a most delicate touch, otherwise the calibration might well be 100 kc/s. (or more) in error.

To proceed with the alignment of the R.F. and Mixer Stages, the Crystal Calibrator is switched off, mode switch to "A.M." and the modulated output from the signal generator connected to the AERIAL 1 and the linked AERIAL 2/EARTH terminals, via the dummy aerial. (Note: — The receiver input impedance is 75 ohms approximately on all bands). The attenuator is set to give an output of between 10 and 20 microvolts.

It is recommended when making a complete re-alignment to start at Range 6 and work upwards in frequency to Range 1.

GENERAL SERVICING — continued

A signal at 1.8 Mc/s. is tuned in on the receiver. The CORES in the R.F. and Mixer stages are then adjusted for maximum output as registered on the output meter. Next, the S.G. is set to 2.0 Mc/s. and the output peaked by adjustment of the TRIMMER CONDENSERS. Adjustment is again made at 1.8 Mc/s. and the procedure repeated until optimum performance is obtained.

The other ranges are aligned in the same way, using the following high and low frequency alignment points on each range (see Fig. 4).

| Range | Trimmer Frequency | Core Frequency | R.F. Coil | Mixer Coil |
|-------|-------------------|----------------|-----------|------------|
| 1 | 30 Mc/s. | 28 Mc/s. | 1 | 2 |
| 2 | 21.5 Mc/s. | 21 Mc/s. | 4 | 5 |
| 3 | 14.3 Mc/s. | 14 Mc/s. | 7 | 8 |
| 4 | 7.3 Mc/s. | 7 Mc/s. | 10 | 11 |
| 5 | 4.0 Mc/s. | 3.5 Mc/s. | 13 | 14 |
| 6 | 2.0 Mc/s. | 1.8 Mc/s. | 16 | 17 |

Finally a 1,620 kc/s. signal is fed in at the aerial terminals and the I.F. Rejector Coil (see Fig. 4) adjusted for MINIMUM output.

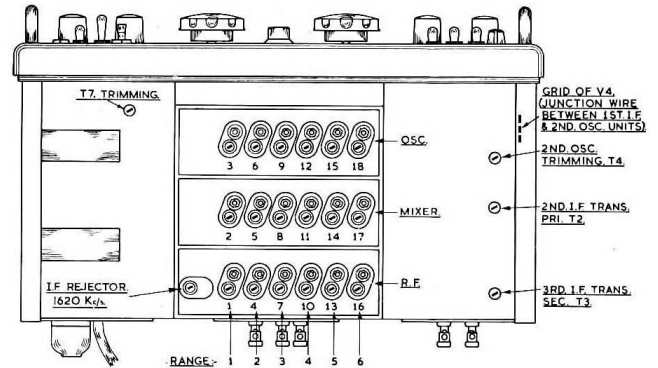

Fig. 4. Underside view of "888 A" Receiver in outline.

INSTALLATION AND OPERATION

The receiver has been carefully aligned and calibrated, and thoroughly tested before despatch. The only adjustment that may be necessary is the mains input voltage. The plug in the selector panel on the transformer is fitted normally in the 230 volt position, where it should remain for voltages between 220 and 250 volts. If the mains voltage is between 195 and 215 volts, the plug should be changed to the 200 volt position. The 110 volt tap is suitable for mains supplies between 100 and 125 volts.

D.C. mains supplies are entirely unsuitable and if connected will cause serious damage. Ensure that the octal plug is in place in the octal socket "B" (nearest the side of the cabinet) as shown in the drawing, Fig. 2.

A loudspeaker of 2.5 to 3 ohms impedance should be connected to the upper terminals at the rear (the Eddystone Cat. No. 688 is especially recommended for use with this receiver), or alternatively high resistance (2,000 to 4,000 ohms) telephones plugged into the jack at the left of the front panel.

The fuse fitted between the H.T. secondary centre tap and chassis is the "Magnickel" delayed type. A standard type of fuse is liable to blow if the receiver is switched off (mains switch) and immediately switched on again without giving the rectifier valve time to cool.

AERIAL CONNECTIONS.

The input impedance of the "888A" receiver is approximately 75 ohms and it is most desirable to match correctly into this impedance if maximum performance and signal-to-noise ratio is to be achieved. A dipole aerial, cut to resonate at the centre of a particular frequency band, and fed at the centre with low impedance feeder, will result in an excellent match but of course on that band only. For multi-band work, any of the popular types of aerial may be employed but, if a serious mismatch would otherwise occur (e.g. a long wire half wave aerial end-fed into the receiver), it will be better to insert a matching device between the aerial and the aerial terminals of the receiver. This may well take the form of a pi-network as commonly used with transmitting equipment.

On the 3.5 and 1.8 Mc/s. bands, the direct attachment of a long wire aerial is liable to produce spurious responses, solely because of the mismatching. In such cases, a very small capacity (2 to 10 pF) should be inserted between the aerial and the aerial terminal.

Balanced feeders are taken to the spring-loaded terminals marked "A1" and "A2" at the rear (see Fig. 2) and a short connection from a good earth made to the terminal marked "E." An unbalanced feeder (e.g. coaxial cable) is connected with the inner lead to "A1" and the outer screen to "A2," a jumper wire being placed across "A2" and "E." A single

wire aerial is connected to "A1" and if possible, it should be of a length equivalent (at the operating frequency) to an odd number of quarter wavelengths — usually one or three quarter waves will be convenient. Otherwise, as mentioned earlier, it will be desirable to include a small capacitor in series with the aerial and, if this is made variable, a good match will usually be possible.

The appropriate lengths for the six bands covered by the "888A" receiver are as follows:—

| BAND | $\frac{1}{4}$ wavelength | $\frac{3}{4}$ wavelength | $\frac{1}{2}$ wave dipole |
|----------------|--------------------------|--------------------------|---------------------------|
| 28/30 Mc/s. .. | 8 ft. | 24 ft. | 16 ft. |
| 21 Mc/s. .. | 11 ft. | 33 ft. | 22 ft. |
| 14 Mc/s. .. | 16½ ft. | 50 ft. | 33 ft. |
| 7 Mc/s. .. | 33 ft. | 99 ft. | 66 ft. |
| 3.5 Mc/s. .. | 67 ft. | 201 ft. | 134 ft. |
| 1.8 Mc/s. .. | 135 ft. | 405 ft. | 270 ft. |

The length of $\frac{1}{4}\lambda$ aeriels are from the far insulator to the aerial terminal and with the $\frac{1}{2}\lambda$ dipole, the total length between the end insulators. On those bands where the length of aerial is considerably shorter than a quarter wavelength — for example a 67 foot wire on 1.8 Mc/s. — a better match will be secured by placing a small loading coil in series with the aerial.

The foregoing is only intended as a rough guide towards obtaining optimum results and for full information on aerial systems, matching arrangements and so on, the reader is referred to the various Handbooks which deal with these specialised subjects.

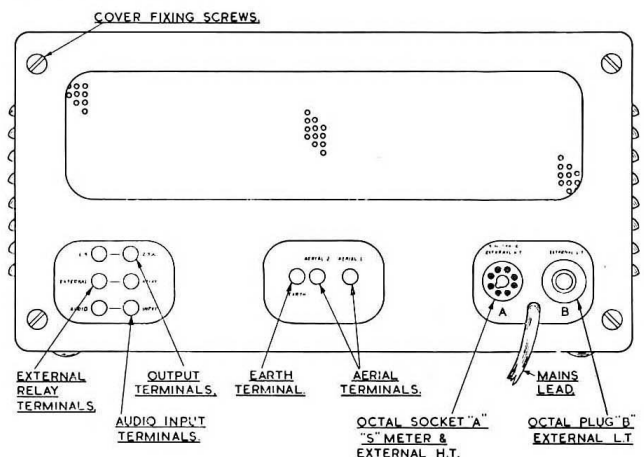

Fig. 2 Rear view of "888 A" Receiver in outline.

RECEPTION OF TELEPHONY.

The mode switch should be in the "A M" position and A.G.C. switched on. For full effectiveness, and particularly when an "S" meter is in use, both RF and IF gain controls should be at maximum (full clockwise rotation), the output being controlled with the AF gain potentiometer on the extreme right.

The variable selectivity control will normally be in the position marked "Minimum," when reasonably good quality of speech will be obtained. When heterodyne interference is experienced, or if much "man-made" noise is in evidence, benefit will be obtained by increasing the selectivity, rotating the butterfly knob counter-clockwise. Only when interference is very severe should it be necessary to operate on telephony with the selectivity control at maximum, and as in this position considerable side-band cutting occurs, it is not then possible to give a true indication of speech quality.

The Cat. No. 669 "S" Meter is a valuable adjunct when the main interest lies in telephony reception. It aids correct tuning and gives a useful comparative reading of the strength of the incoming carrier. Thus the "S" Meter will indicate, for example, when a beam aerial is correctly pointing at a given station and, if a matching unit is employed, the Meter will show when optimum matching adjustments have been made.

RECEPTION OF C.W. SIGNALS.

Moving the mode switch to the "SSB-CW" position takes the diode de-modulator out of circuit and applies HT to the BFO/mixer converter stage, when the receiver is ready to accept CW (Morse) signals and also single sideband telephony

The adjustment of the controls depends on a number of factors including the strength of incoming signals, amount of interference present and the efficiency of the aerial. If the latter is poor, it will be advisable to use maximum RF gain at all times but, if good, often the RF gain can be reduced somewhat with advantage, particularly on strong signals.

A certain amount of skill is called for in adjusting the IF gain and selectivity controls, to secure optimum results. When receiving telephony, the overall gain is automatically controlled according to the strength of the incoming signal but, with CW, manual control of IF gain is important.

The IF gain varies with the setting of the selectivity control and is greatest when selectivity is minimum. It will rarely be desirable to employ full gain with selectivity at minimum. As the degree of selectivity is increased, gain should be maintained by advancing the IF gain control.

It is advantageous to employ a high degree of selectivity because the noise output from the receiver is lower when the bandwidth is narrow, for an equal amount of gain. With the selectivity control at or near maximum, signals very close to one another can be separated and weak signals made to stand out clearly against the quiet background.

The pitch control gives a swing of three kilocycles each side of centre and will normally be set to give a beat note of 800/1,000 cycles. It will be noticed that on tuning through a signal, the beat on one side is much stronger than on the other. This "single signal" effect is of advantage since unwanted interference can often be removed by suitable adjustment of the pitch control.

RECEPTION OF SINGLE SIDEBAND TELEPHONY.

Single sideband telephony is, in effect, modulation only and, before the signal can be made intelligible, a local carrier has to be provided. In the "888 A" the beat oscillator supplies this carrier and the same valve also operates as a mixer, converting the signal directly to audio frequency. Since the strength of the local oscillator is constant, it is necessary to use the RF and IF gain controls to bring the incoming signal to the level which results in the proper depth of modulation.

Whilst SSB signals can at times be found anywhere within the amateur bands, certain narrow sections are recognised unofficially and will usually be found just below the high frequency edges. For example, in Europe, near 3790/3795 kc/s. is used; in North America 3990 kc/s. and, for long distance work, 14290 kc/s. is used internationally. It is further recognised that the lower sideband be employed on

the lower frequencies (e.g. 3-7 Mc/s) and the upper sideband on the higher frequencies.

The controls on the "888A" are initially set as follows: Audio gain fully advanced; mode switch to "SSB-CW"; RF gain at or near maximum; IF gain well backed off. Normally only frequencies up to 2700/3000 c.p.s. are transmitted, hence a similar bandwidth in the receiver is appropriate. No benefit (rather the reverse) is secured by using a lower degree of selectivity. The selectivity control should therefore be in a position some half or third advanced from maximum and the pitch control set well to one side or the other - to the left for the lower sideband and to the right for the upper sideband.

On tuning through an SSB signal, at first unintelligible speech will be heard. If the signal is weak, RF gain should be advanced fully and possible IF gain also increased. If the signal is strong, RF gain should be reduced. Careful tuning towards the "inside" of the signal (i.e. moving the tuning control to the right on 3.5-4.0 Mc/s., and vice-versa on the HF bands) will result in the speech being resolved. The pitch control now comes in useful as a vernier adjustment, to render the speech clear and distinct, and some further slight improvement may result by adjustment to the RF and IF gain controls.

As with A3 telephony, there can exist wide variations in quality of the transmitted signals, and the foregoing procedure of course assumes the transmitter is correctly adjusted.

AUDIO FILTER.

The audio filter unit is of advanced design. As can be seen in Fig. 6 which shows the response curve, the filter peaks sharply at 1,000 cycles, and of equal importance is the low insertion loss - only 1db at the resonant frequency. In consequence of these characteristics, the filter, when switched in, will remove interfering signals and noise and bring up the intelligibility of a signal, weak or strong. With its aid, Morse signals can even be copied through telephony, since the latter becomes quite unreadable.

CRYSTAL CALIBRATOR.

The accuracy of the oscillator in the crystal calibrator is checked during factory alignment, but a small trimmer is provided for screwdriver adjustment, should this be deemed necessary at any time. The calibrator gives marker points 100 kc/s. apart and the harmonics are audible on all ranges, although naturally not so strong at the higher frequencies as on the lower ones.

To ensure accurate dial calibration, the procedure is as follows. With mode switch at "CW" the pitch is set to the central position (white spot at top). The scale pointer is made to coincide with a mark which is an exact multiple of 100 kc/s. on the particular band in use. On pressing the panel switch, incoming signals (unless very strong) will be muted and rotation of the "Oscillator Trim" knob will result in the harmonic beat being heard. The knob is left in the "null" position between the two beat notes. The dial accuracy can then be relied upon for close readings, and it will only be necessary to repeat the procedure when the band is changed.

CONNECTION OF "S" METER.

The Eddystone Cat. No. 669 "S" Meter is recommended for use with the "888A" Receiver. It incorporates a sensitive moving-coil meter of 200 microamperes full scale deflection.

The flexible lead from the meter terminates in an octal plug which should be inserted in the socket marked "A" in Fig. 2 at the rear of the receiver.

Reference to the circuit diagram of the receiver will show that one half of the double-diode V7 is in series with the meter movement. This prevents reverse current flowing through the meter when the balance is disturbed and the meter can be left in circuit under all conditions of operation without likelihood of damage. The bottom bend characteristic of the diode results in sluggish action at low signal strengths and, to overcome this, the needle of the meter is purposely offset below the zero mark on the scale by means of the mechanical adjuster.

INSTALLATION AND OPERATION — continued

With the receiver controls set for reception of telephony, the aerial and earth terminals (or doublet terminals) should be shorted and the "S" Meter needle made to coincide with zero by adjustment of the electrical balance control at the rear of the meter. On removing the short, the meter will indicate comparative carrier strength.

NOISE LIMITER.

In a quiet situation, it will not be necessary to make use of the noise limiter but when electrical interference of a staccato nature is experienced (on telephony or CW), switching on the noise limiter will effectively remove a high percentage of the interfering noise, with little effect on the strength of the signal and without introducing distortion. The noise limiter must not be expected to act effectively with noise of a mushy type, as generated by vacuum cleaners and other electrical equipment incorporating motors — these should be filtered with suppressors at the source.

In a noisy location, it is well to erect an aerial well in the clear and as far as possible from electric light wiring.

The stronger the incoming signal, the more the gain of the receiver can be reduced (automatically on telephony, manually on CW) thereby reducing also the effect of any interference being picked up.

USE OF THE STANDBY SWITCH.

The Standby switch, in the "off" position, desensitises the receiver to a degree governed by the internal control described later. The system is considered preferable to cutting the H.T. supply, for several reasons. The oscillator valves continue to operate under normal conditions, thereby preventing any change of frequency during standby periods and, since the audio stages remain "alive," a monitor signal can be fed into the pick-up terminals and become audible on the loudspeaker or telephones.

The switch can also be used to control associated equipment such as a transmitter. Leads from one pair of contacts are taken to terminals at the rear (see Fig. 2) and these contacts are closed when the switch is in the standby ("Off") position. Externally the circuit will consist of a relay and an energising source, usually 6 or 12 volts D.C. but some relays work on A.C. of both high and low voltages. This master relay can then be used, if desired, to control other relays carrying out such functions as automatic aerial changeover, monitor on/off, modulator supplies and so on.

STANDBY SENSITIVITY.

The receiver itself can be used as a monitor of the outgoing signal from an associated transmitter, operated on either Morse or telephony. Inside the receiver and accessible when the lid is opened (see Fig. 3) is a knob which controls the sensitivity of the receiver when the switch is in the "Standby" position. This enables the strength of the monitor signal to be adjusted to a suitable level, irrespective of the power used in the transmitter and other local circumstances.

It is desirable to prevent an excessive RF voltage reaching the aerial terminal (and so the first tuned circuit) during transmission periods and the leads from the aerial relay or switch should be kept reasonably short. If a separate aerial is used for reception, arrangements should be made for disconnecting or earthing it during transmission, the most convenient way of doing so being the use of a small relay.

AERIAL TRIMMING CONTROL.

Also inside the receiver is a small knob which controls a variable condenser, connected in parallel with the first tuned circuit. Different types of aerial, and particularly those showing large degrees of reactance, are liable to upset the alignment of the RF stage and, the aerial trimmer is used to bring the circuit back to exact resonance. The control needs to be adjusted only once for each range (or when the aerial is changed) and is set for maximum signal level.

OPERATION FROM SIX VOLT ACCUMULATOR.

The "888A" receiver may be operated from a 6 volt accumulator in conjunction with a special Vibrator Unit, Cat. No. 687/1. Installation details are provided with the Unit.

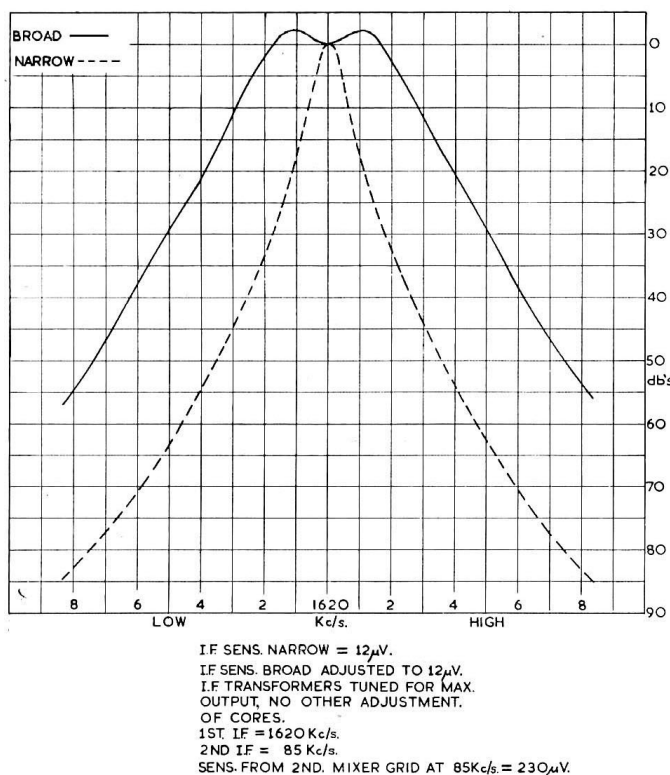

Fig. 5 Overall selectivity at extreme positions of the control, in the "888A" receiver. I.F. sensitivity with control in narrow position is approximately 12 microvolts. The broad curve is taken at maximum selectivity, with the I.F. sensitivity adjusted to 12 microvolts.

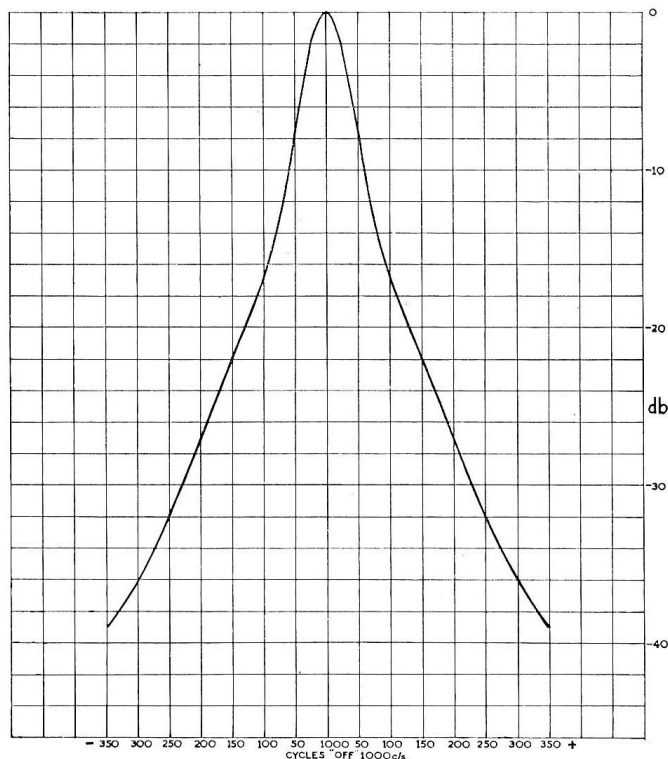

Fig. 6 Response curve resulting when the audio filter is switched into circuit.

EDDYSTONE "888 A"

VOLTAGE VALUES.

The voltages are between the points indicated and chassis. Set Receiver at 28 Mc/s. on range 1 with the aerial shorted out. I.F. and R.F. controls set at maximum. A.F. gain control set at minimum with all controls on except crystal calibrator which is switched on for points D—, E—.

| <i>Circuit Ref.</i> | <i>20,000 ohms/Volt</i> | <i>AVO Model 40</i> |
|---------------------|-------------------------|---------------------|
| A | 250 | 237 |
| B | 100 | 86 |
| C | 1 | 1 |
| D | 99 | 90 |
| E | 250 | 241 |
| F | 1.92 | 1.75 |
| G | 98 | 70 |
| H | 96 | 86 |
| J | 250 | 241 |
| K | 1.9 | 1 |
| L | 105 | 93 |
| M | 105 | 90 |
| N | 255 | 247 |
| P | 1.1 | 1 |
| Q | 115 | 40 |
| R | 1.37 | 0.7 |
| S | 255 | 250 |
| T | 245 | 240 |
| U | 13 | 11.7 |
| V | 150 | 150 |
| W | 255 | 250 |
| X | 275 | 270 |
| Y | 250 A.C. | 245 A.C. |
| Z | 250 A.C. | 245 A.C. |
| A— | 55 | 44 |
| B— | 200 | 144 |
| C— | 1.9 | 1.0 |
| D— | 20 | 7 |
| E— | 182 | 130 |
| F— | 10 | 2.4 |

Total D.C. consumption 110 mA.

Input 75 VA.

EDDYSTONE "888 A" COMPONENT VALUES

CONDENSERS.

| | | | | | | | | |
|-----|------------|----------------------|-----|------------|---------------------|------|-----------|------------------------|
| C1 | 2.5-33 pF. | Air Trimmer | C40 | 100 pF. | Tub. Ceramic | C79 | 30 mfd. | 15V. Tub. electrolytic |
| C2 | 80 pF. | Silvered mica | C41 | 500 pF. | Tub. Paper | C80 | .01 mfd. | Moulded Mica |
| C3 | 2.5-33 pF. | Air Trimmer | C42 | 500 pF. | Tub. Paper | C81 | 4 mfd. | Tub. electrolytic |
| C4 | 35 pF. | Silvered Mica | C43 | .01 mfd. | Tub. Paper | C82 | .007 mfd. | Silvered Mica |
| C5 | 2.5-33 pF. | Air Trimmer | C44 | 2.5-33 pF. | Air Trimmer | C83 | .007 mfd. | Silvered Mica |
| C6 | 20 pF. | Silvered Mica | C45 | 30 pF. | Tub. Ceramic | C84 | 500 pF. | Moulded Mica |
| C7 | 2.5-33 pF. | Air Trimmer | C46 | 120 pF. | Silvered Mica | C85 | .01 mfd. | Moulded Mica |
| C8 | 40 pF. | Silvered Mica | C47 | 2.5-33 pF. | Air Trimmer | C86 | 6 pF. | Silvered Mica |
| C9 | 2.5-33 pF. | Air Trimmer | C48 | 30 pF. | Tub. Ceramic | C87 | .01 mfd. | Moulded Mica |
| C10 | 2.5-33 pF. | Air Trimmer | C49 | 2.5-33 pF. | Air Trimmer | C88 | .25 mfd. | Tub. Paper |
| C11 | 100 pF. | Silvered Mica | C50 | 400 pF. | Silvered Mica | C89 | 50 mfd. | Tub. electrolytic |
| C12 | 8-34 pF. | RF section 3 gang | C51 | 2.5-33 pF. | Air Trimmer | C90 | 0.1 mfd. | Tub. Paper |
| C13 | .01 mfd. | Tub. Paper | C52 | 200 pF. | Silvered Mica | C91 | | |
| C14 | 20 pF. | Silvered Mica | C53 | 2.5-33 pF. | Air Trimmer | C92 | 100 pF. | Silvered Mica |
| C15 | | Aerial Trimmer | C54 | 2.5-33 pF. | Air Trimmer | C93 | 200 pF. | Silvered Mica |
| C16 | 0.1 mfd. | Tub. Paper | C55 | 50 pF. | Silvered Mica | C94 | | B.F.O. Pitch |
| C17 | 0.1 mfd. | Tub. Paper | C56 | 8-34 pF. | Osc. section 3 gang | C95 | .01 mfd. | Tub. Paper |
| C18 | .01 mfd. | Tub. Paper | C57 | 40 pF. | Tub. Ceramic | C96 | .5 mfd. | Tub. Paper |
| C19 | 2.5-33 pF. | Air Trimmer | C58 | 2.5-4 pF. | Air Trimmer | C97 | .5 mfd. | Tub. Paper |
| C20 | 80 pF. | Silvered Mica | C59 | 0.1 mfd. | Tub. Paper | C98 | | |
| C21 | 2.5-33 pF. | Air Trimmer | C60 | .01 mfd. | Tub. Paper | C99 | .01 mfd. | Moulded Mica |
| C22 | 35 pF. | Silvered Mica | C61 | 800 pF. | Silvered Mica | C100 | 50 mfd. | Tub. electrolytic |
| C23 | 2.5-33 pF. | Air Trimmer | C62 | 800 pF. | Silvered Mica | C101 | 30 mfd. | 15V. Tub. electrolytic |
| C24 | 20 pF. | Silvered Mica | C63 | 0.1 mfd. | Tub. Paper | C102 | 20 pF. | Silvered Mica |
| C25 | 2.5-33 pF. | Air Trimmer | C64 | 100 pF. | Silvered Mica | C103 | 40 pF. | Silvered Mica |
| C26 | 40 pF. | Silvered Mica | C65 | 100 pF. | Silvered Mica | C104 | 80 pF. | Silvered Mica |
| C27 | 2.5-33 pF. | Air Trimmer | C66 | 200 pF. | Silvered Mica | C105 | 35 pF. | Tub. Ceramic |
| C28 | 2.5-33 pF. | Air Trimmer | C67 | .01 mfd. | Tub. Paper | C106 | 200 pF. | Silvered Mica |
| C29 | 100 pF. | Silvered Mica | C68 | .01 mfd. | Tub. Paper | C107 | 20 pF. | Silvered Mica |
| C30 | 8-34 pF. | Mixer section 3 gang | C69 | .01 mfd. | Tub. Paper | C108 | .01 mfd. | Tub. Paper |
| C31 | 20 pF. | Silvered Mica | C70 | 800 pF. | Silvered Mica | C109 | 3-23 pF. | Air Trimmer |
| C32 | .01 mfd. | Tub. Paper | C71 | 800 pF. | Silvered Mica | C110 | 1 pF. | Silvered Mica |
| C33 | 0.1 mfd. | Tub. Paper | C72 | 500 pF. | Silvered Mica | C111 | 30 mfd. | Tub. Elect. 15V. |
| C34 | 0.1 mfd. | Tub. Paper | C73 | 20 pF. | Silvered Mica | C112 | 30 mfd. | Tub. Elect. 15V. |
| C35 | .01 mfd. | Tub. Paper | C74 | 0.1 mfd. | Tub. Paper | C113 | 500 pF. | Tub. Paper |
| C36 | 200 pF. | Silvered Mica | C75 | 0.1 mfd. | Tub. Paper | C114 | 500 pF. | Tub. Paper |
| C37 | 200 pF. | Silvered Mica | C76 | 100 pF. | Silvered Mica | C115 | 5000 pF. | Tub. Paper |
| C38 | 0.1 mfd. | Tub. Paper | C77 | 100 pF. | Silvered Mica | C116 | .25 mfd. | Moulded Paper |
| C39 | 200 pF. | Tub. Ceramic | C78 | 0.1 mfd. | Tub. Paper | | | |

RESISTORS.

| | | | | | | | | |
|-----|-------------|---------------|-----|-------------|---------------|-----|-------------|------------|
| R1 | 1,000 ohms | | R22 | 1,000 ohms | | R43 | 330 ohms | |
| R2 | 33,000 ohms | 1 watt | R23 | 33,000 ohms | 1 watt | R44 | 2.0 megohm | |
| R3 | 68,000 ohms | | R24 | 10,000 ohms | | R45 | 68,000 ohms | |
| R4 | 12 ohms | | R25 | 47,000 ohms | | R46 | | |
| R5 | 0.47 megohm | | R26 | 150 ohms | | R47 | 33,000 ohms | |
| R6 | 68 ohms | | R27 | 27,000 ohms | | R48 | | |
| R7 | 10,000 ohms | Potentiometer | R28 | 0.27 megohm | | R49 | 2,700 ohms | Wire wound |
| R8 | 1,000 ohms | | R29 | 47 ohms | | R50 | 0.1 megohm | |
| R9 | 10,000 ohms | | R30 | 1,000 ohms | | R51 | 6,800 ohms | |
| R10 | 0.47 megohm | | R31 | 33,000 ohms | | R52 | 0.47 megohm | |
| R11 | 0.47 megohm | | R32 | 0.47 megohm | | R53 | .1 megohm | |
| R12 | | | R33 | 3,300 ohms | | R54 | 3 megohm | |
| R13 | 220 ohms | | R34 | 68 ohms | | R55 | 22,000 ohms | |
| R14 | 0.47 megohm | | R35 | 0.1 megohm | | R56 | .27 megohm | |
| R15 | 47,000 ohms | | R36 | 0.1 megohm | | R57 | 1 megohm | |
| R16 | 1,000 ohms | | R37 | 1.0 megohm | | R58 | 22,000 ohms | |
| R17 | 10,000 ohms | | R38 | 0.47 megohm | | R59 | 220 ohms | |
| R18 | 27,000 ohms | 1 watt | R39 | 0.47 megohm | | R60 | 0.47 megohm | |
| R19 | 1,000 ohms | | R40 | 0.5 megohm | Potentiometer | R61 | 47,000 ohms | |
| R20 | | | R41 | 50,000 ohms | Potentiometer | R62 | 10,000 ohms | |
| R21 | 12 ohms | | R42 | 10,000 ohms | Potentiometer | R63 | 47 ohms | |

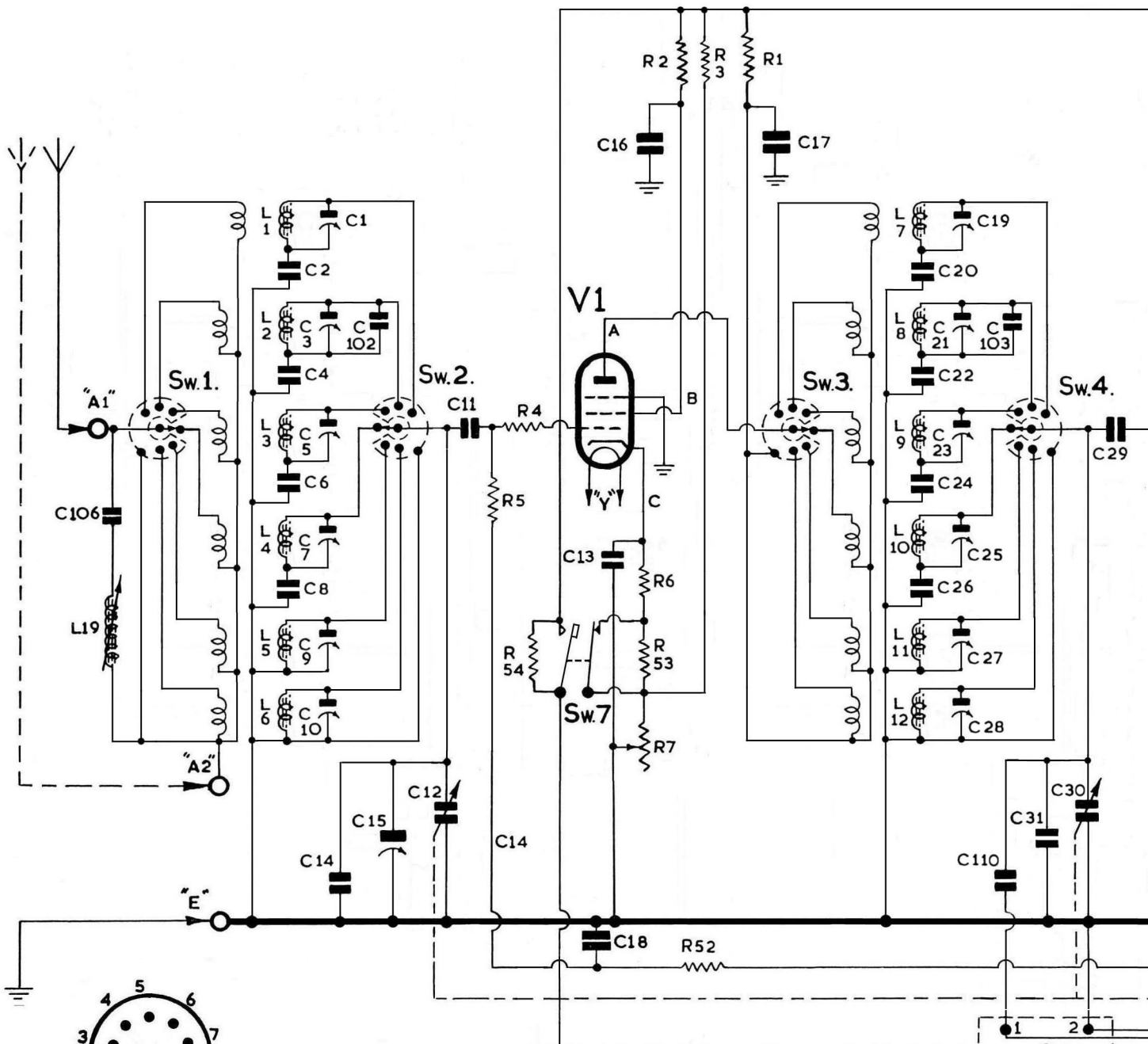

VIEWED FROM BENEATH SOCKET.

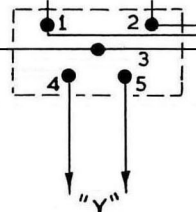

B9A (NOVAL) SERIES.

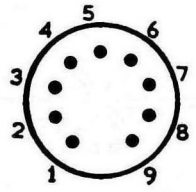

OCTAL SERIES

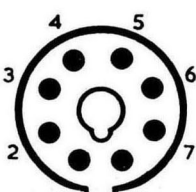

B7G SERIES.

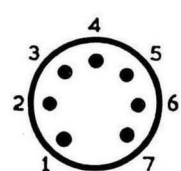

| VALVE | V. No. | PIN CONNECTIONS | | | | | | | SERIES | |
|----------|--------|-----------------|----|----|----|----|----|----|--------|--------|
| | | 1 | 2 | 3 | 4 | 5 | 6 | 7 | | |
| 6BA6 | V1,5 | G1 | G3 | H | H | A | G2 | K | - | B7G. |
| ECH81 | V2,4 | G2 | G1 | K | H | H | AH | G3 | AT | B9A. |
| 6C4 | V3 | A | - | H | H | A | G | K | - | B7G. |
| 5Z4G | V10 | - | H | - | A2 | - | A1 | - | H | OCTAL. |
| VR150/30 | V11 | - | K | - | - | A | - | - | - | OCTAL. |
| 6AL5 | V7 | K1 | D2 | H | H | K2 | S | D1 | - | B7G. |
| 6AT6 | V6 | G1 | K | H | H | D1 | D2 | A | - | B7G. |
| 6AQ5 | V8 | G1 | K | H | H | A | G2 | G1 | - | B7G. |
| XTL. | - | G1 | G1 | G1 | - | E | E | E | - | B7G. |
| 6BE6 | V9 | G1 | K | H | H | A | G2 | G3 | - | B7G. |
| 6AU6 | V12 | G1 | G3 | H | H | A | G2 | K | - | B7G. |

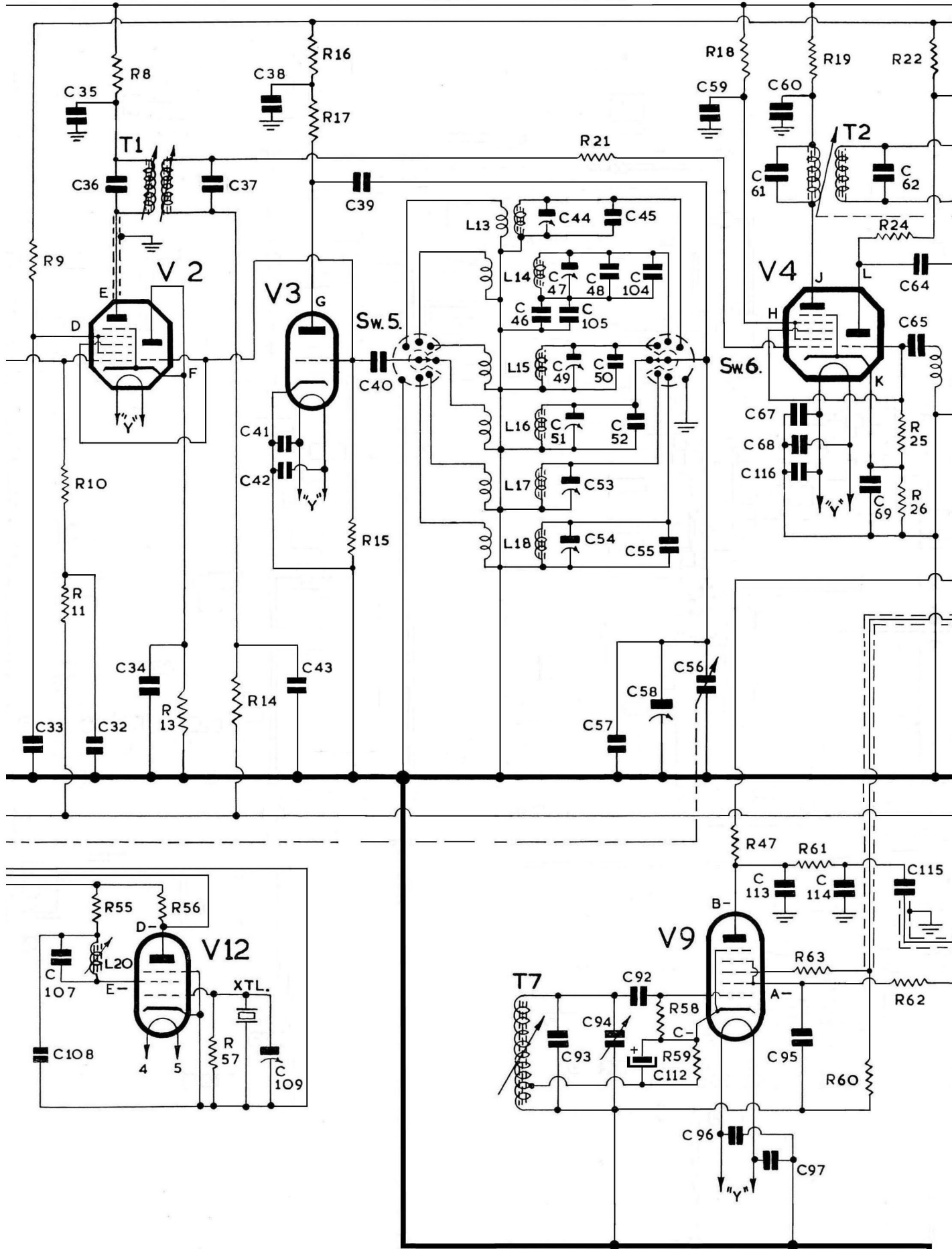

EDDYSTONE "888A"

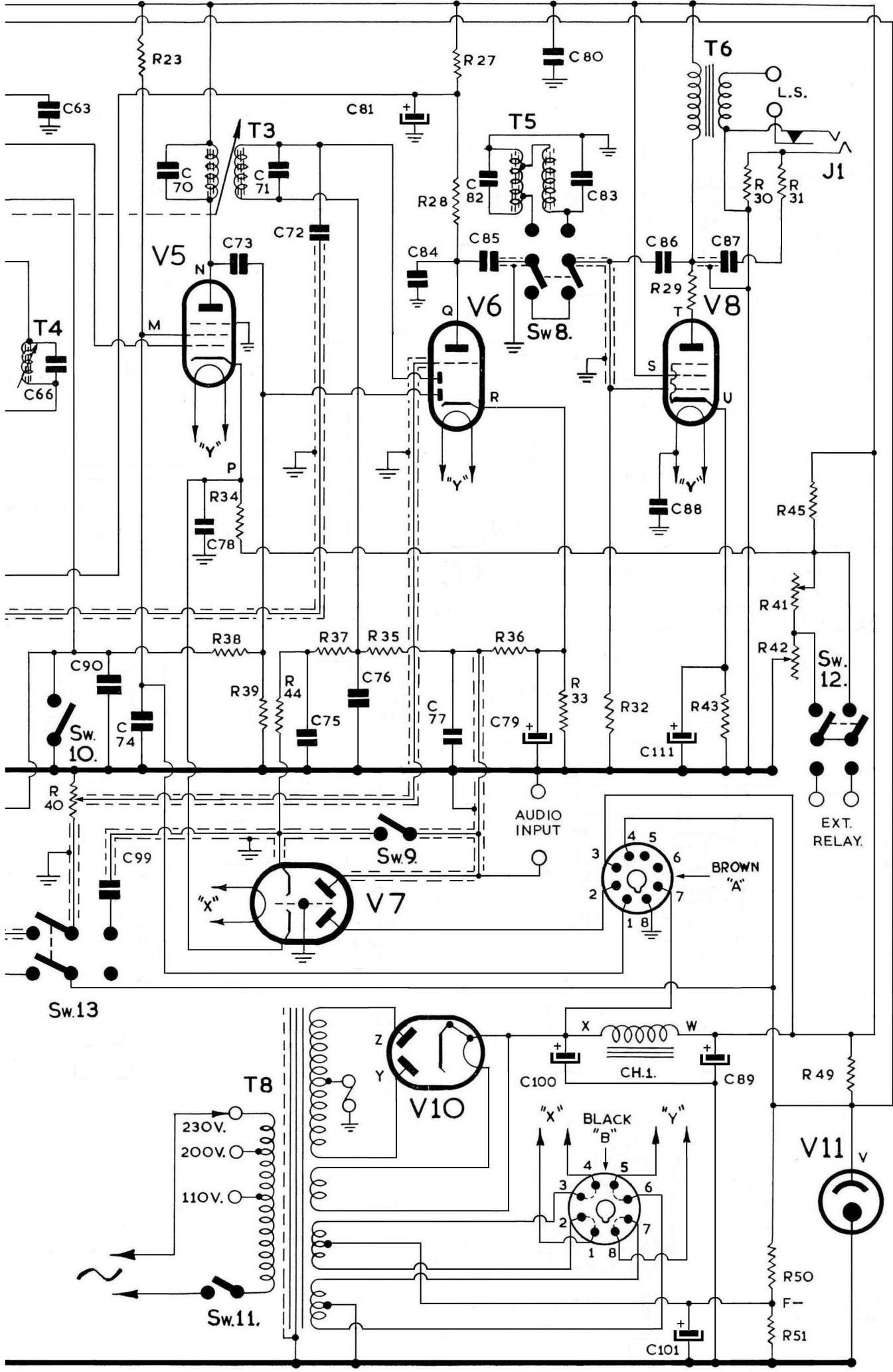

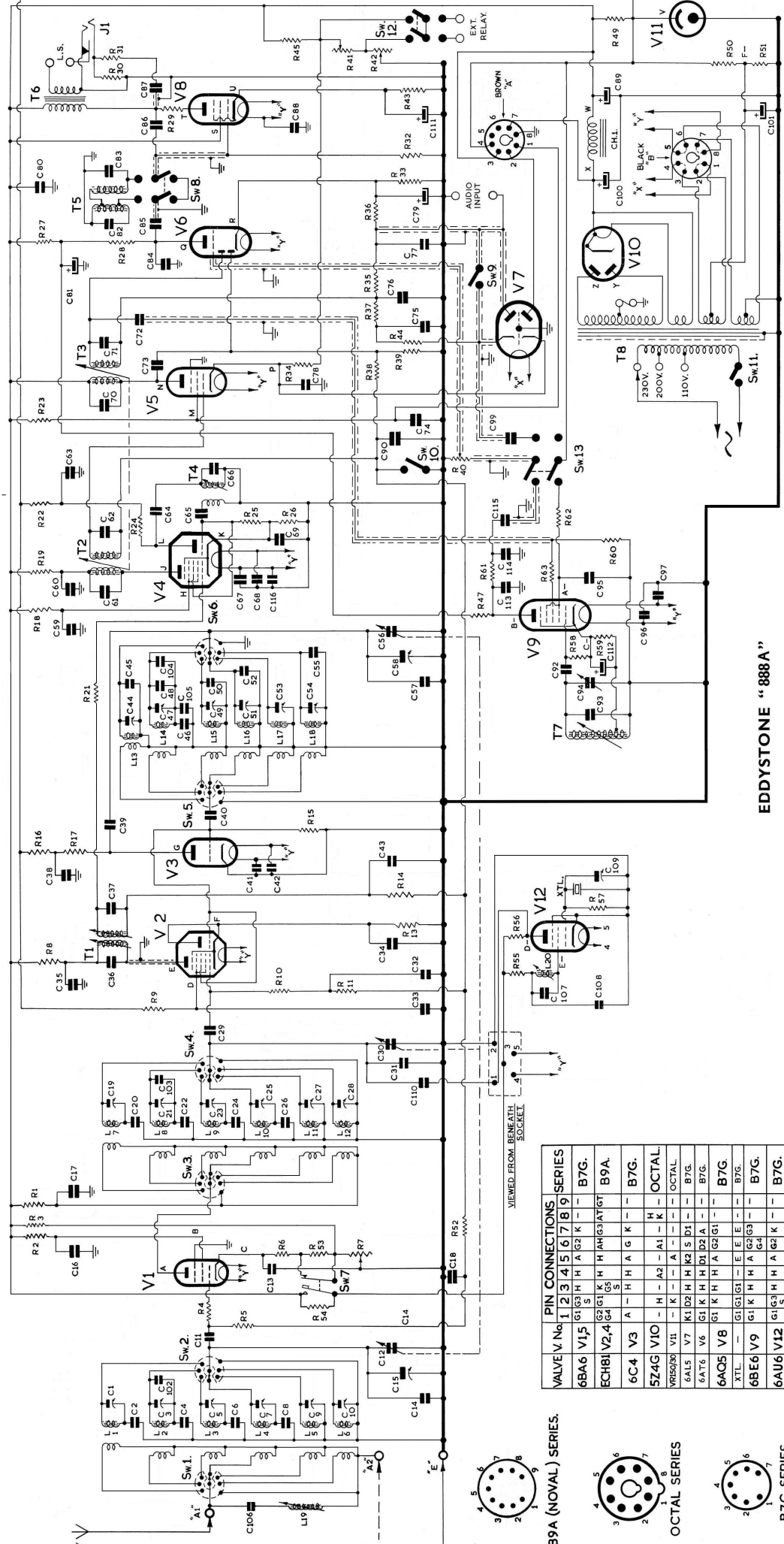

EDDYSTONE "888A"

PIN CONNECTIONS

| VALVE V. No. | 1 | 2 | 3 | 4 | 5 | 6 | 7 | 8 | 9 | SERIES | | | |
|--------------|-----|----|---|---|---|---|---|---|---|--------|-------|---|------|
| 6BA6 | G1 | H | A | G | K | - | - | - | - | B7G. | | | |
| ECH81 | G2 | G1 | K | H | A | H | G | A | G | B9A. | | | |
| 6C4 | A | - | H | A | G | K | - | - | - | B7G. | | | |
| 5Z4G | V10 | - | H | - | A | 2 | - | A | 1 | - | OCTAL | | |
| 6AL5 | V7 | K | 1 | D | 2 | H | K | 2 | S | D | 1 | - | B7G. |
| 6AT6 | V6 | G | 1 | K | H | D | 1 | D | 2 | A | - | - | B7G. |
| 6AQ5 | V8 | G | 1 | K | H | A | G | 2 | G | 1 | - | - | B7G. |
| XTL. | - | G | 1 | G | 1 | G | 1 | - | - | - | - | - | B7G. |
| 6BE6 | V9 | - | E | - | E | - | - | - | - | - | - | - | B7G. |
| 6AU6 | V12 | G | 1 | G | 1 | H | A | G | 2 | K | - | - | B7G. |

VIEWED FROM BENEATH SOCKET

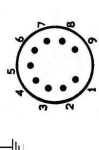

B9A (NOVAL) SERIES.

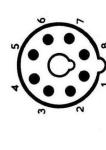

OCTAL SERIES

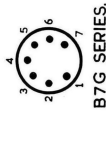

B7G SERIES.